

LACE ZIPPER PILLOW BACK INSTRUCTIONS

Perfectly Pieced

Lace Zipper Closure for Any Size Pillow

Important: To make the pillow cover, first follow the instructions below under **Sewing the Pillow Back**. Then, follow either the **Standard Finish** instructions **OR** the **Binding Finish** instructions, depending on the type of finish desired.

These instructions work for any pillow size.

Note: Only use nylon coil zippers for these instructions. You will be sewing across the teeth of your zipper. Nylon coil zippers are suitable for this purpose. **Sewing across other types of zippers may damage your sewing machine.**

SEWING THE PILLOW BACK

1.

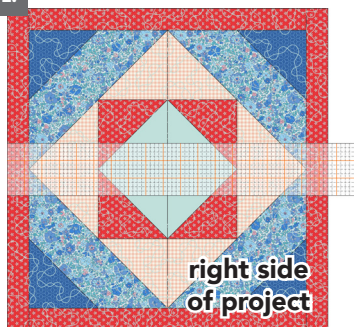

Measure the finished pillow front through the center horizontally.

2.

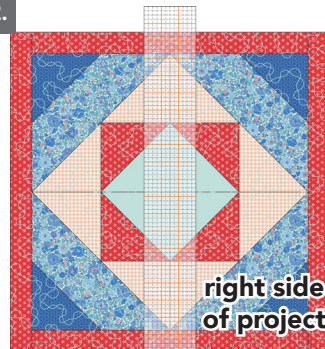

Measure the finished pillow front through the center vertically.

3.

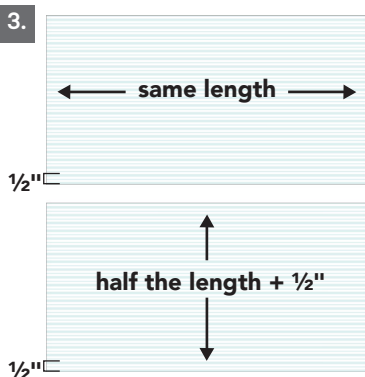

Measure and cut (2) pieces of Back Fabric that are the **same length horizontally** as the pillow front, but **half the length vertically**, then **add 1/2"** on the vertical side of each back piece.

One piece will be the Lower Back Fabric and one will be the Upper Back Fabric.

4.

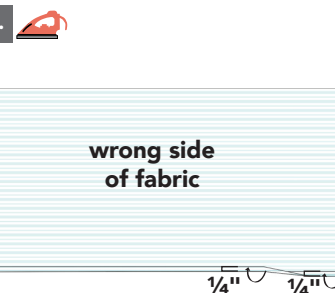

Fold one long edge of the Lower Back Fabric over 1/4" to the **wrong side** and press well.

Fold the same long edge over another 1/4" to create a finished edge. Press well.

5.

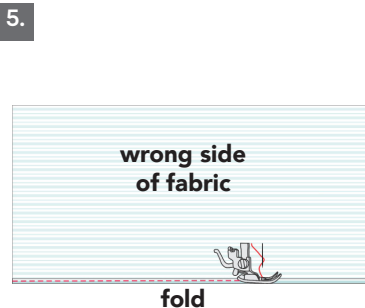

Topstitch the fold.

6.

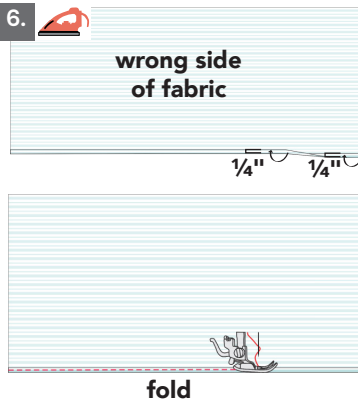

Repeat Steps 4-5 with the Upper Back Fabric.

7.

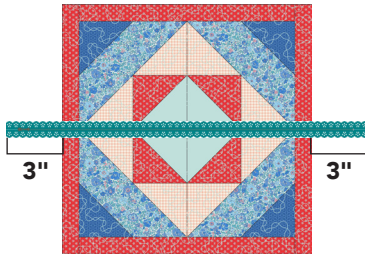

Choose a lace zipper that is **longer** than your project and will extend past the project edges by at least 3" on both sides.

8.

wrong side of zipper



Place the lace zipper **horizontally** on a flat surface, **right side down**, with the zipper pull to the **right**.

9.

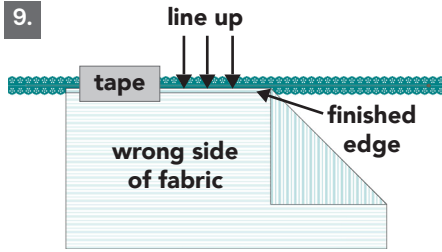

Place the Lower Back Fabric **right side down** with the finished edge on **top** of the zipper, just **below** the zipper teeth. Tape in place.

10.

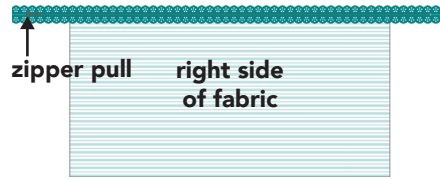

Turn the project **right side up**. The zipper pull should be to the **left**.

11.



Topstitch the lace zipper next to the zipper teeth.

Note: A zipper foot is helpful.

12.

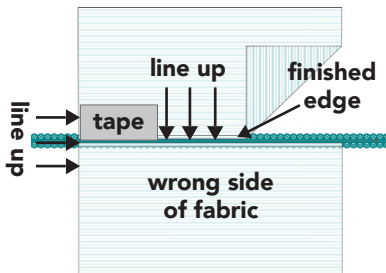

Place the project **right side down**. Place the Upper Back Fabric with the finished edge on **top** of the zipper and just **above** the zipper teeth. Align the Upper and Lower Back Fabric side edges. Tape in place.

13.

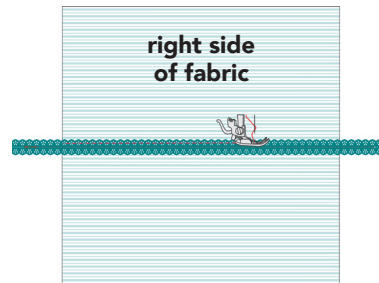

Turn the project **right side up**.

Topstitch the lace zipper next to the zipper teeth.

This completes the pillow back.

STANDARD FINISH

1.

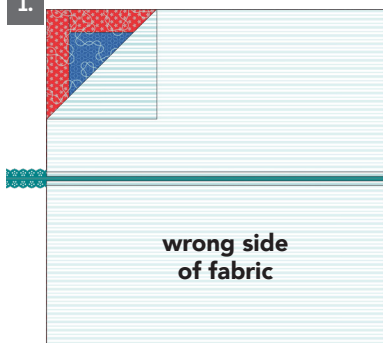

Place the pillow front **right side up** on a flat surface. **Center** the pillow back **right sides together** on top of the pillow front. The zipper pull should be to the **right**.

2.

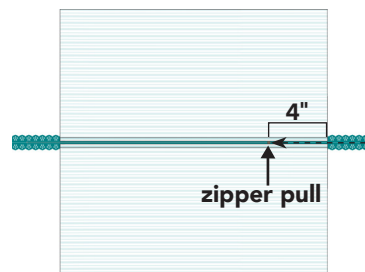

Open the zipper until the pull is 4" inside the edges of the project.

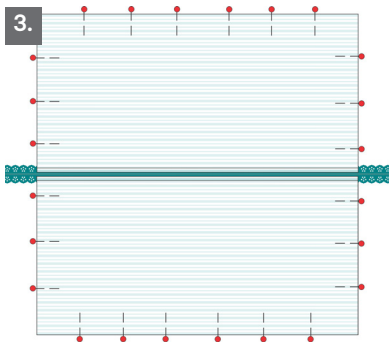

3. Pin the project all the way around the edges.

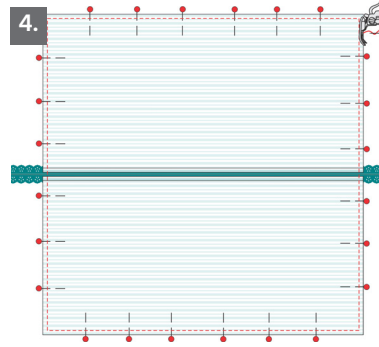

4. Sew around the perimeter of the pillow with a $\frac{1}{4}$ " seam allowance. Backstitch when sewing over the zipper to reinforce the ends. Remove the pins.

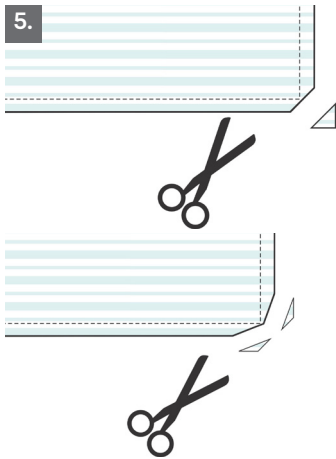

5. Clip the corners to reduce bulk. Trim across the corner seam allowance, being careful not to cut through the stitches.

Trim again at a slight angle, from the corner up the seam allowance, about 1" on each side to reduce bulk.

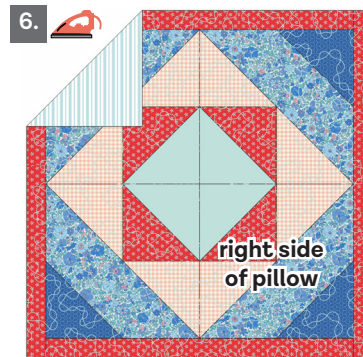

6. Turn the pillow cover **right side out** through the zipper. Square the corners with a blunt tip and press well.

Place pillow insert inside pillow.

BINDING FINISH

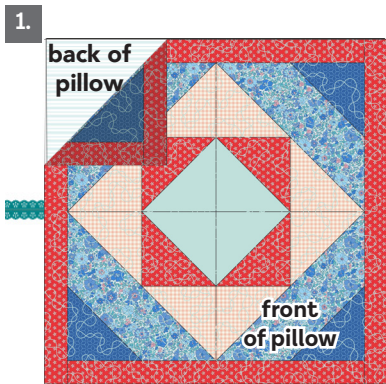

1. Place the pillow front and pillow back **wrong sides together** on a flat surface. The zipper pull should be to the **right**.

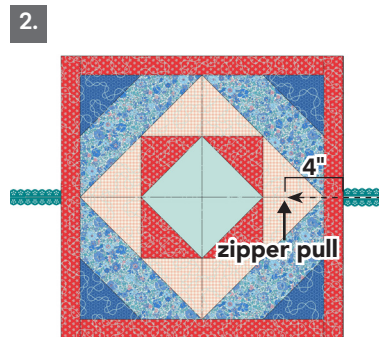

2. Open the zipper until the pull is 4" inches inside the edges of the project.

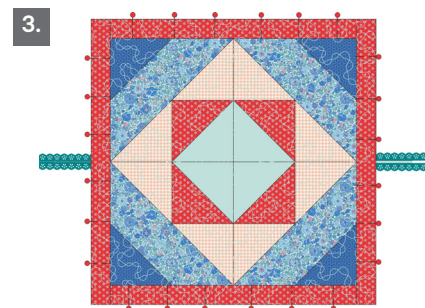

3. Pin the project all the way around the edges.

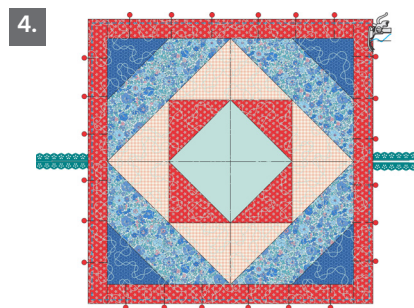

4. Sew a basting stitch around the perimeter of the pillow with a scant $\frac{1}{4}$ " seam allowance. Backstitch when sewing over the zipper to reinforce the ends. Remove the pins. Trim the zipper even with the edges of the pillow. Be sure the zipper pull is inside the edges of the project.

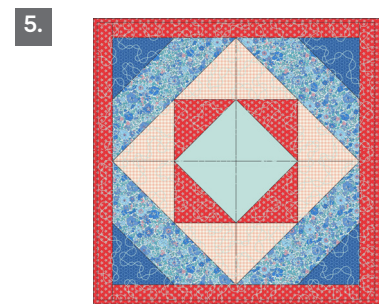

5. Follow the instructions on pages 30-33 to bind the edges. Place pillow insert inside pillow.